

The background of the cover is a collage of various floor tile samples. On the left, there are vertical strips of different colors and textures, including a light beige, a dark grey, and a black. The right side features larger rectangular tiles with various patterns and textures, such as a light grey with a grid pattern, a dark grey with a diamond pattern, and a light grey with a wavy pattern. The overall aesthetic is modern and minimalist.

FLOORS

Ceramica **Bardelli**

INDEX

PRODOTTO <i>PRODUCT</i>	PAGINA <i>PAGE</i>
Trame	8
Clayborn	12
HexaMatt	16
Lines	18
Zip	22
Palladiana	28
Pittorica	32

History



60 anni di storia

In occasione del nostro 60° anniversario, consolidiamo la nostra presenza come Gruppo Bardelli Spa: un ritorno alle origini, alla famiglia, con una strategia orientata al futuro, che combina la memoria storica, l'indiscussa competenza, l'esperienza tecnica e di design con l'intraprendenza delle nuove generazioni.

60 years of history

On the occasion of our 60th anniversary, we want to consolidate our presence as Bardelli Group Spa: back to the origin, back to the family, with a future-oriented strategy that combines the memorable history, the undisputed skill, the technical and design expertise with the entrepreneurial spirit of new generations.

Family



Il Board, la Famiglia, il Futuro

Il board attualmente è composto da Alberto Bardelli, Presidente, Gianmaria Bardelli e Gianandrea Bardelli, Amministratori Delegati, e Antonio De Marco, Direttore Generale. Specializzazione nel piccolo formato, investimenti in nuove tecnologie nella decorazione ceramica, flessibilità produttiva: sono gli obiettivi del nostro piano strategico di sviluppo

The Board, the Family, the Future

The Board of Directors is currently composed by Alberto Bardelli, Chairman, Gianmaria Bardelli and Gianandrea Bardelli, Managing Directors, and Antonio De Marco, General manager. Specialization in small formats, investment in new technologies for decorative ceramics, flexibility in production: these are the objectives of our strategic development plan.



Qualità e Sostenibilità del Made in Italy

Una attenta selezione delle migliori materie prime del settore ci consente di valorizzare il modello dell'economia circolare sostenibile per ridurre l'impronta ambientale e sviluppare un quadro olistico di sostenibilità.

Quality and Sustainability of Made in Italy

A careful selection of the best raw materials in the field allows us to promote a sustainable circular economy to reduce our environmental footprint and develop a holistic sustainable strategy.

Innovation

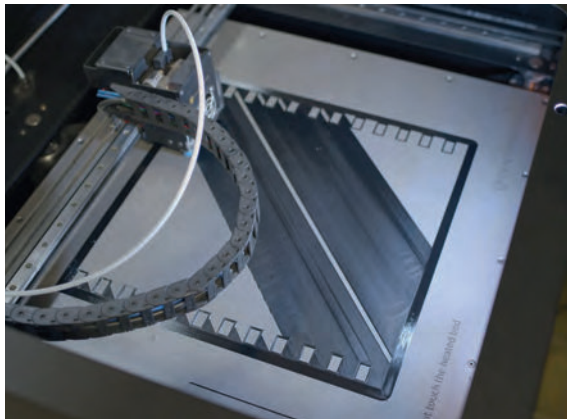

Innovazione nella Tradizione

Ceramica Bardelli rappresenta un mix vincente di eccellenza qualitativa tipica del Made in Italy e soluzioni espressive di design visionario, dove il know-how aziendale viene messo al servizio di prestigiose collaborazioni con designer e architetti nazionali e internazionali.

Innovation in Tradition

Ceramica Bardelli represents a successful blend of quality excellence, typical of Made in Italy, and solutions that express visionary design, where the company's know-how is shared for prestigious collaborations with national and international designers and architects.

Design



Creatività, ricerca e sviluppo











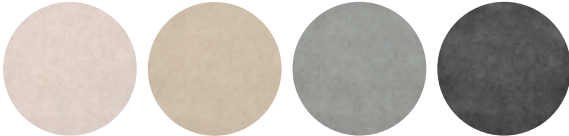

Design è rigore di progetto, scelta di modernità, modo di comunicare.

Scegliere ceramiche di Design significa realizzare scenari fortemente connotati, caratterizzati da una rigorosa concezione dello spazio.

Creativity, research and development

Design is planning rigour, choice of modernity, it is a way to communicate. Using artistic ceramics means creating strongly accented scenarios, distinguished by a rigorous conception of space.

FLOORS COLLECTION

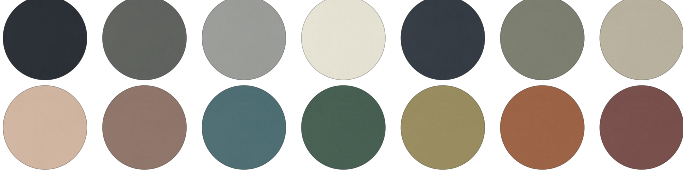
COLLECTIONS	COLORS
 <p>TRAME</p>	
 <p>CLAYBORN</p>	
 <p>HEXA MATT</p>	
 <p>LINES</p>	
 <p>ZIP</p>	
<p>PALLADIANA</p> 	
 <p>PITTORICA</p>	

MATERIALS	THICKNESS			FORMAT		PAGE
	0,6cm	0,85cm	1cm	Large sizes	Small sizes	
<p>Gres porcellanato colorato in massa (full body), rettificato monocalibro.</p> <p><i>Full colored body stoneware, single calibre rectified.</i></p>	●			●		8-11
<p>Gres porcellanato rettificato.</p> <p><i>Rectified porcelain tiles</i></p>			●	●		12-15
<p>Gres porcellanato.</p> <p><i>Porcelain tiles.</i></p>		●			●	16-17
<p>Gres porcellanato rettificato.</p> <p><i>Rectified porcelain tiles.</i></p>			●	●		18-21
<p>Gres porcellanato rettificato.</p> <p><i>Rectified porcelain tiles.</i></p>			●	●		22-27
<p>Gres porcellanato colorato in massa rettificato monocalibro.</p> <p><i>Rectified full-body coloured porcelain stoneware monocalibre.</i></p>			●	●		28-31
<p>Gres smaltato e rettificato.</p> <p><i>Rectified glazed stoneware.</i></p>			●		●	32-37



*"The art of balancing
functionality with
aesthetics."
Matt Mitchell*

TRAME

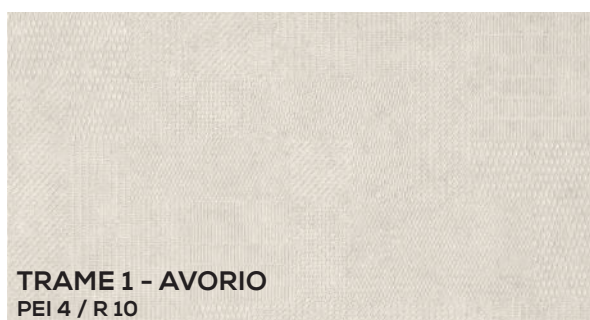

FORMATS

60x120cm (24"x48") - 120x120cm (48"x48")



THICKNESS

6mm ($\frac{25}{64}$ ")



MATERIALS

Gres porcellanato colorato in massa (full body), rettificato monocalibro.
Full colored body stoneware, single calibre rectified.



ANTI-SLIP RESISTANCE

R10



ABRASION RESISTANCE

PEI 4



DYNAMIC FRICTION

DCOF



VISIT THE COLLECTION



Collezione di piastrelle da pavimento e rivestimento in gres porcellanato colorato in massa (full body), rettificato monocalibro. Formato 60x120 e 120x120 cm, spessore 6 mm, finitura materica opaca disponibile in tre colori.

Collection of 60x120 cm (24"x48") - 120x120 cm (48"x48") full colored body stoneware for floor and wall, reduced thickness 6 mm, single calibre rectified, matt finish available in three colors.







*"The AI is the digital brush
that amplifies the power of
the human mind to paint
new masterpieces"
by Chat GPT*

CLAYBORN

design AI

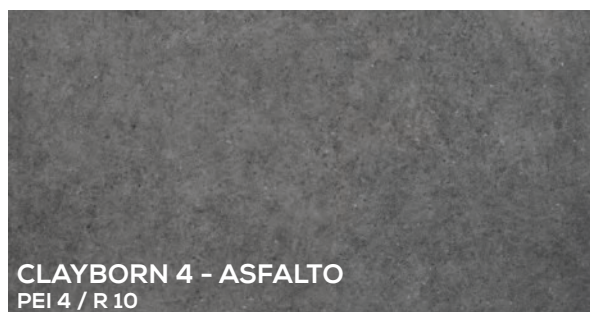
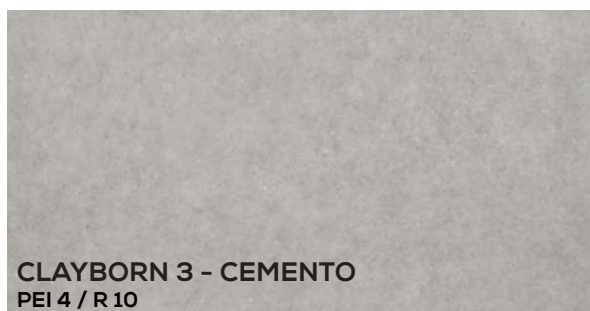
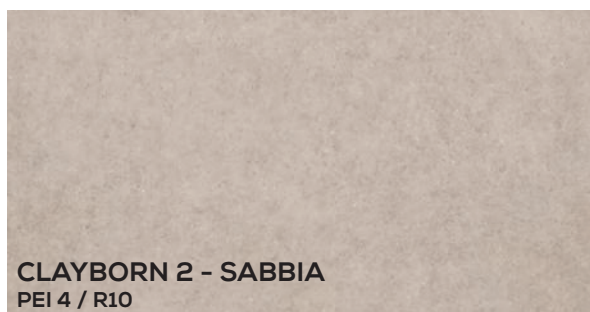
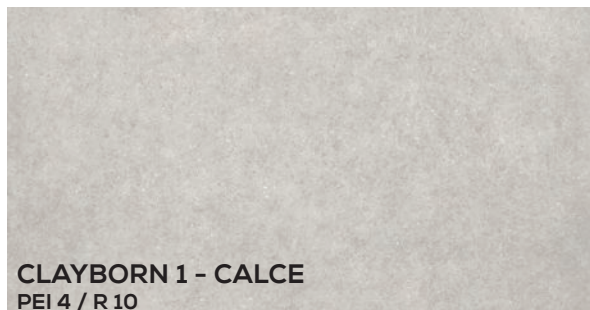

FORMATS

60x60cm (24"x24") - 60x120cm (24"x48")



THICKNESS

10mm ($\frac{25}{64}$ ")



MATERIALS

Gres porcellanato rettificato
Rectified porcelain tiles



ANTI-SLIP RESISTANCE

R10



ABRASION RESISTANCE

PEI 4



DYNAMIC FRICTION

DCOF



VISIT THE COLLECTION



Collezione di piastrelle in grès porcellanato rettificato, adatta per un utilizzo a pavimento e rivestimento. La collezione, caratterizzata da tagli di grandi dimensioni è disponibile in due formati 60x60, 60x120 cm - spessore 1 cm e quattro famiglie di colore.

A collection of rectified porcelain tiles for use on floors and walls. The collection is characterised by a choice of two large sizes - 60x60 cm (24"x24") and 60x120 cm (48"x48") - thickness 1 cm and four colour families





BAR, rivestimento / covering CLAYBORN 1 (60x120 cm - 24" x 48"), pavimento / floor CLAYBORN 1 (60x120 cm - 24" x 48").



*"Colors speak all languages."
Joseph Addison*

HEXA MATT

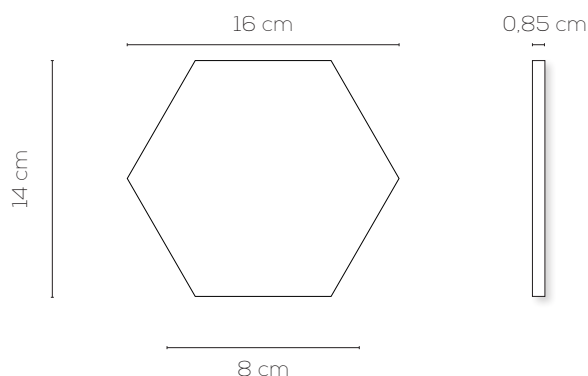

FORMATS

14x16 cm (5 ³³/₆₄" x 6 ¹⁹/₆₄")



THICKNESS

8,5mm ²¹/₆₄"



MATERIALS

Gres porcellanato.
Porcelain tiles.



ANTI-SLIP RESISTANCE

R9



ABRASION RESISTANCE

PEI 2 -PEI 4



DYNAMIC FRICTION

DCOF



VISIT THE COLLECTION



Collezione di piastrelle da pavimento e rivestimento d'interni ed esterni, realizzata in gres porcellanato, composta da sei colori opachi formato 14x16 cm, spessore 0,85 cm.

Collection of 14x16 cm porcelain stoneware for indoor and outdoor, floor and wall available in six matt colors, thickness 0,85 cm



*"...a bold architectural
character;
a tile collection
in an international
contemporary spirit"*

LINES

design Storaemilano

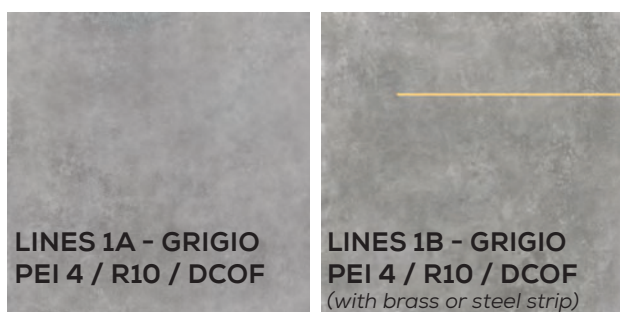
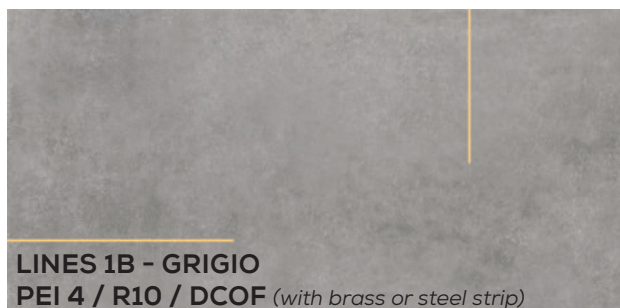
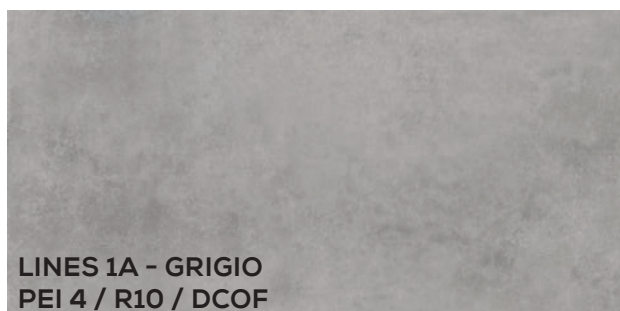

FORMATS

60x60cm (24"x24") - 60x120cm (24"x48")



THICKNESS

10mm ($\frac{25}{64}$ ")



MATERIALS

Gres porcellanato rettificato
Rectified porcelain tiles



ANTI-SLIP RESISTANCE

R10



ABRASION RESISTANCE

PEI 3 -PEI 4



DYNAMIC FRICTION

DCOF



VISIT THE COLLECTION



Collezione di piastrelle in gres porcellanato rettificato, adatta per un utilizzo a pavimento e rivestimento. È disponibile in due formati - 60x60 e 60x120 cm - tre famiglie di colore. Completa la collezione una versione decorata a mano: un prezioso listello metallico in ottone satinato o acciaio viene inserito manualmente all'interno della superficie smaltata, rendendo esclusiva ogni singola piastrella.

A collection of rectified porcelain tiles for floors and walls use. It's available in two sizes 60x60 and 60x120 cm - three colour families. The collection is further enriched with a variant decorated by hand: a prestigious matt brass strip or steel strip is manually incorporated in the enameled surface, adding an exclusive touch to every single tile.



LUXURY HOUSES
LUXURY WINERY ESTATES
LUXURY WINE & SPIRITS
LUXURY HOMES

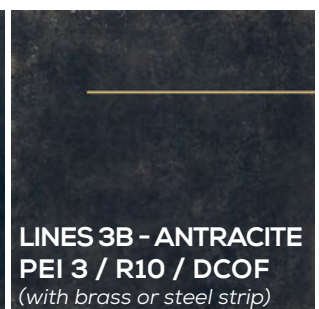
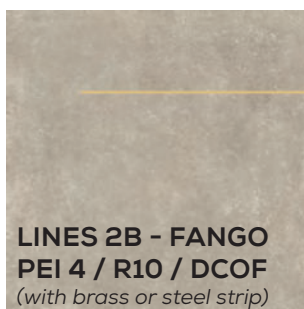
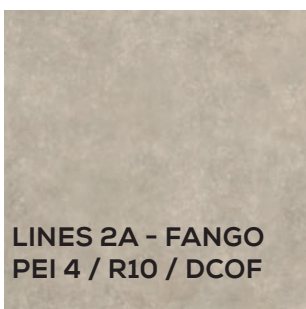

FORMATS

60x60cm (24"x24") - 60x120cm (24"x48")



ANTI-SLIP RESISTANCE

R10



THICKNESS

10mm ($\frac{25}{64}$ ")



ABRASION RESISTANCE

PEI 3 - PEI 4



MATERIALS

Gres porcellanato rettificato



DYNAMIC FRICTION

DCOF



VISIT THE COLLECTION





"Zip transforms ceramics into a dynamic visual system, perpetually hovering between rhythm and asymmetry."

ZIP

design Meneghello Paoletti Associati



ZIP 1A - AVORIO
PEI 5 / R10 / DCOF

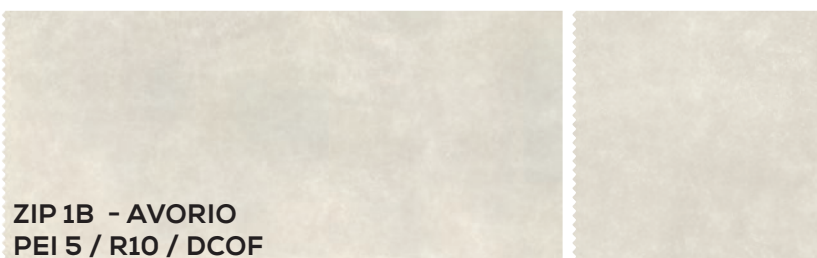

ZIP 1B - AVORIO
PEI 5 / R10 / DCOF



ZIP 1C - AVORIO
PEI 5 / R10 / DCOF



FORMATS

60x60cm (24"x24") - 60x120cm (24"x48")



THICKNESS

10mm ($\frac{25}{64}$ ")



MATERIALS

Gres porcellanato rettificato
Rectified porcelain tiles



ANTI-SLIP RESISTANCE

R10



ABRASION RESISTANCE

PEI 3 - PEI 4 - PEI 5



DYNAMIC FRICTION

DCOF



VISIT THE COLLECTION

GIUNTI / JOINT SUGGESTION



Collezione di piastrelle in gres porcellanato rettificato, adatta per un utilizzo a pavimento e rivestimento. Le piastrelle, nel formato 60x60 e 60x120 cm, sono disponibili nella versione base o con bordi sagomati. Entrambe si presentano in tre colori. Finitura opaca e texture uniforme, spessore 10 mm. Per garantire la modularità tra fondi e decori è necessario l'utilizzo di distanziatori da 2 mm procedendo ad una doppia operazione di stuccatura.

Collection of rectified glazed porcelain tiles, suitable for both floor and wall. Tiles are available with both plain and shaped edges, in the format 60x60cm and 60x120cm. Both versions present three different colors. Matt finish and uniform texture, 10mm thickness. In order to guarantee the modularity between the base and decors, it is necessary to use 2mm spacers, proceeding with a double grouting operation.

ZIP

design Meneghello Paoletti Associati

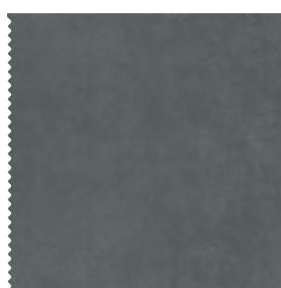
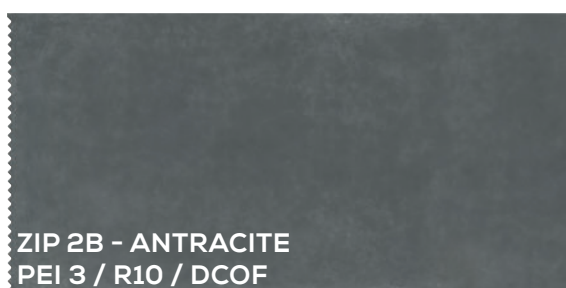

GIUNTI / JOINT SUGGESTION

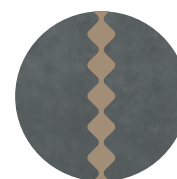
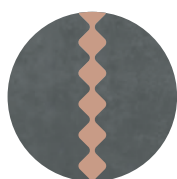
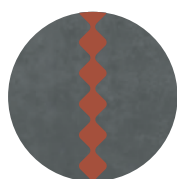
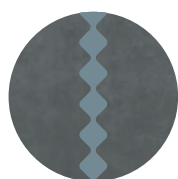

ZIP

design Meneghello Paoletti Associati

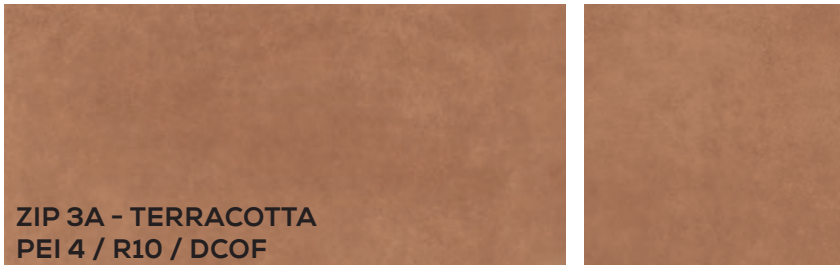

FORMATS

60x60cm (24"x24") - 60x120cm (24"x48")



THICKNESS

10mm ($\frac{25}{64}$ ")



MATERIALS

Gres porcellanato rettificato



ANTI-SLIP RESISTANCE

R10



ABRASION RESISTANCE

PEI 3 - PEI 4 - PEI 5



DYNAMIC FRICTION

DCOF



VISIT THE COLLECTION



GIUNTI / JOINT SUGGESTION



Kerakoll 42

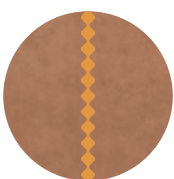

Kerakoll 27

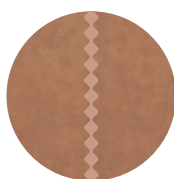

Mapei 141



Mapei 132

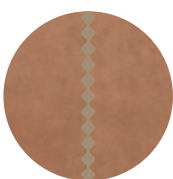

Mapei 134



BAGNO / BATHROOM, rivestimento / covering ZIP 2B (60x120 cm - 24"x48"), pavimento / floor ZIP 1A-1B (60x60 cm - 24"x24").
Fuga/Joint Mapei 145



LIVING, rivestimento / covering ZIP 1A-1C (60x120 cm - 24"x48")
Fuga/Joint Mapei 171

"... a unique and sophisticated chromatic alphabet, perfect for enhancing spaces where ceramics are not commonly used."



PALLADIANA

design Studiopepe



FORMATS

60x60cm (24"x24") - 60x120cm (24"x48")



THICKNESS

✂ 10mm ($\frac{25}{64}$ ")



MATERIALS

Gres porcellanato colorato in massa rettificato monocalibro.
Rectified full-body coloured porcelain stoneware monocalibre.



ANTI-SLIP RESISTANCE

R10



ABRASION RESISTANCE

PEI 3 - PEI 4 - PEI 5



DYNAMIC FRICTION

DCOF



VISIT THE COLLECTION



Collezione di piastrelle da pavimento e rivestimento in gres porcellanato colorato in massa, rettificato monocalibro. Finitura materica opaca che evidenzia la tridimensionalità. Disponibile in quattro colori, nei formati 60x60 cm e 60x120 cm spessore 10 mm. Tutti gli articoli sono realizzati in sei differenti disegni, per consentire una posa d'insieme compatibile e ogni volta diversa.

Collection of coloured body, rectified monocalibre porcelain tiles, for both floor and wall covering. Matt textured finish that highlights the 3D of the material. Available in four different colours, in size 60x60 cm and 60x120 cm, 10 mm thickness. All the items are produced in six different designs, in order to offer a compatible overall layout, that is different every time.







*"Pittorica is the poetry
of the imagination,
rhymes of graphic
patterns and hues of
colour"*

PITTORICA

design Studioepe



25x25cm (10"x10")

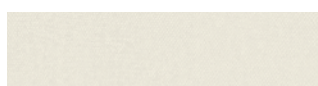

6x25cm (2³/₈"x10")



25x25x35cm (10"x10"x14")



1x25cm (2⁵/₆₄"x10")

Pezzo speciale polifunzionale: terminale di rivestimento, cornice, angolo esterno (in alternativa allo spigolo smussato a 45°)

Multifunctional - special piece:
terminal wall tiles, frame, external corner
(as an alternative to the jolly)



FORMATS

25x25cm (10"x10") - 6x25cm (2³/₈"x10") -
25x25x35cm (10"x10"x14")



THICKNESS

✂ 10mm (2⁵/₆₄")



MATERIALS

Gres smaltato e rettificato.
Rectified glazed stoneware.



ANTI-SLIP RESISTANCE

R10



ABRASION RESISTANCE

PEI 2 - PEI 3 - PEI 4 - PEI 5



DYNAMIC FRICTION

DCOF



VISIT THE COLLECTION



Collezione di piastrelle da pavimento e rivestimento d'interni, in gres smaltato e rettificato, composta da quattordici colori opachi suddivisi in tre categorie - neutri, di fondo e di testa - e declinata in tre formati diversi. La scelta della tinta unita opaca è arricchita con una texture materica che richiama la trama di una tela stampata sulla piastrella. Tutti i formati di Pittorica, quadrato - 25x25 cm - rettangolare - 6x25 cm - e triangolare - 25x25x35 cm, spessore mm 10, sono compatibili tra loro, e consentono schemi decorativi articolati e creativi. La capacità decorativa di Pittorica viene esaltata dai nuovi formati rettificati, in grado di garantire soluzioni di posa a fuga minima.

A collection of indoor floor and wall tiles made of rectified glazed stoneware, including fourteen matt colours in three categories - neutral, background and accent colours, and available in three different sizes. The choice of solid matte is enriched with a textured texture that recalls the texture of a canvas printed on the tile. All Pittorica shapes and sizes, square 25x25 cm - rectangular 6x25 cm and triangular 25x25x35 cm, with a thickness of 10 mm - can be mixed and matched to permit complex, creative decorative schemes. The decorative properties of Pittorica are enhanced by the new rectified formats, which guarantee laying solutions with minimal joints for both floors and walls, bringing out the full, modern spirit of colour expressiveness.

COLORI DI FONDO / BACKGROUND COLOURS

25x25cm (10"x10")

25x25x35cm (10"x10"x14")

6x25cm (2³/₈"x10")

1x25cm (2⁵/₆₄"x10")
(pezzo speciale - special piece)



PITTORICA 5 / M
PEI 2 / R10 / DCOF



PITTORICA 6 / M
PEI 3 / R10 / DCOF



PITTORICA 7 / M
PEI 4 / R10 / DCOF

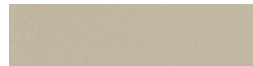

PITTORICA 8 / M
PEI 4 / R10 / DCOF

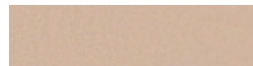

PITTORICA 9 / M
PEI 3 / R10 / DCOF



COLORI BASE NEUTRI / BASIC NEUTRAL COLOURS



PITTORICA 1 / M
PEI 2 / R10 / DCOF



PITTORICA 2 / M
PEI 2 / R10 / DCOF



COLORI DI TESTA / ACCENT COLOURS

25x25cm (10"x10")



25x25x35cm (10"x10"x14")



6x25cm (2³/₈"x10")



1x25cm (2⁵/₆₄"x10")
(pezzo speciale - special piece)



COLORI BASE NEUTRI / BASIC NEUTRAL COLOURS

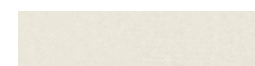





CONFIGURA CON NOI LA TUA IDEA



Vieni a scoprire il nostro **configuratore online** che ti permetterà di rendere il tuo ambiente unico e personalizzato

Discover our **online configurator** that will allow you to make your space unique and personalised

CUSTOM



CUSTOM



PAVIMENTO



DETTAGLIO

Clicca su un colore e scegli tra le varianti della collezione.



PITTORICA 14/M



PITTORICA 4/M

RIVESTIMENTO



DETTAGLIO

Clicca su un colore e scegli tra le varianti della collezione.



PITTORICA 14/M



PITTORICA 4/M

PROGETTA IL TUO SPAZIO



Scarica tutte le texture delle collezioni Ceramica Bardelli per personalizzare i tuoi progetti

Download all the textures of the Ceramica Bardelli collections to customise your projects

DESIGN DIRECTOR:
Gianmaria Bardelli

UFFICIO STAMPA:
OGS PR&Communication
info@ogscommunication.com

FOTO:
Nova Visualis, Iride, Photofoyer/Irene De Luca, Paola Pansini, Deauville/Unopiù, Andrea Ferrari, Panier/Arbi, Mad Mogensen

Ceramica Bardelli
Sede legale
Via Pascoli, 19
20009 Vittuone (Milano) - Italy
Sede amministrativa
Via Papa Giovanni XXIII, 100 - loc. Vergnasco
13882 Cerrione (BI) - Italia
tel. +39.015.6721

info@ceramicabardelli.com
ceramicabardelli.com

Ceramica**Bardelli**

Ceramica Bardelli is a registered trademark of

**GRUPPO
BARDELLI**



Gruppo Bardelli S.p.a.
è Socio Ordinario del GBC



Ceramics of Italy

Gruppo Bardelli S.p.a.
è Socio Ordinario Ceramics of Italy



I prodotti Gruppo Bardelli S.p.a.
hanno certificazione CE



Ceramica**Bardelli**

ceramicabardelli.com
@ceramicabardelli

Milano Italia